

6

5

4

3

2

1



REV	ECN	LOCATIONS	DESCRIPTION	DATE	DESIGN	APVD
A	131031		PRODUCTION	2013.10.31	陈佐君	

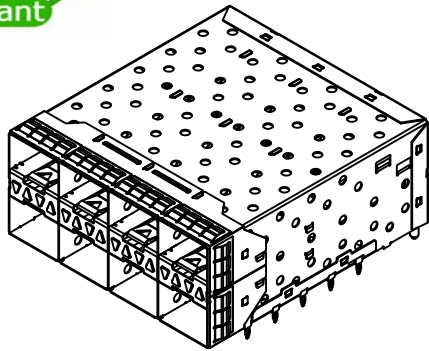

(4 LIGHT PIPE)  
E90-K410-4004

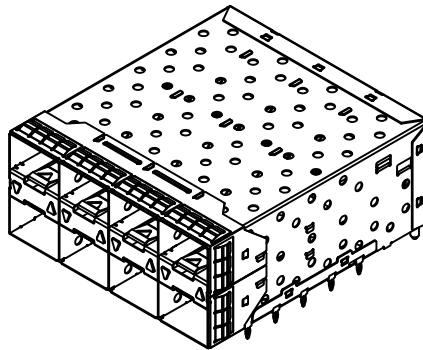

(2 OUTER LIGHT PIPE)  
E90-K410-4002

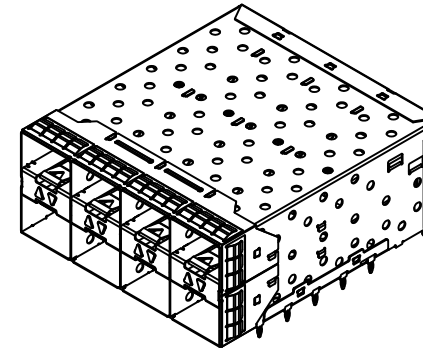

(2 INNER LIGHT PIPE)  
E90-K410-4003

PART NUMBER CONFIGURATION

E90-K410-400X

LIGHT PIPE OPTION

- 1 = 4 LIGHT PIPE
- 2 = 2 OUTER LIGHT PIPE
- 3 = 2 INNER LIGHT PIPE

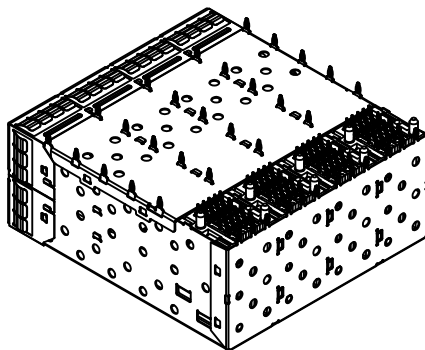

NOTES:

MATERIAL:  
CAGE: NICKEL SILVER

CONNECTOR:  
PLASTIC HOUSING: HIGH TEMPERATURE LCP, UL94 V-0.  
LIGHT PIPE: POLYCARBONATE; COLOR: CLEAR  
SPRING: STAINLESS STEEL  
CONTACTS: PHOSPHOR BRONZE  
CONTACT PLATING: 15u" MIN. GOLD ON MATING AREA,  
150u" MATTE TIN ON SOLDER TAILS

PACKAGING: TRAY PACKAGING.

TEMPERATURE RANGE: -40°C TO +85°C

DIMENSIONS ARE IN INCHES TOLERANCES UNLESS OTHERWISE SPECIFIED: X ± -- X.X ± 0.10 X.XX ± 0.05 X.XXX ± -- ANGLES ± 1°	APPROVALS	NAME	DATE	东莞市浩程电子科技有限公司 DONG GUAN FU CHENG ELECTRONIC TECHNOLOGY Co., LTD
	DESIGNED	陈佐君	2013.10.31	
	CHECKED			TITLE:
	APPROVED			SFP+ 2X4 COMBO WITH LIGHT PIPE WITHOUT GROUNDING PIN
PROPRIETARY AND CONFIDENTIAL THE INFORMATION CONTAINED IN THIS DRAWING IS THE SOLE PROPERTY OF <YAEF ELECTRONICS>. ANY REPRODUCTION IN PART OR AS A WHOLE WITHOUT THE WRITTEN PERMISSION OF <YAEF ELECTRONICS> IS PROHIBITED.				SIZE
MATERIAL&FINISH: SEE NOTES				DWG. NO. E90-K410-400X REV. A
DO NOT SCALE DRAWING				SCALE: 1:1
CUSTOMER DRAWING				SHEET 1 OF 4

6

5

4

3

2

1

6 5 4 3 2 1

REV	ECN	LOCATIONS	DESCRIPTION	DATE	DESIGN	APVD
A	131031		PRODUCTION	2013.10.31	陈佐君	

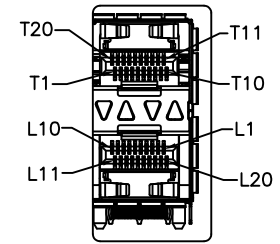
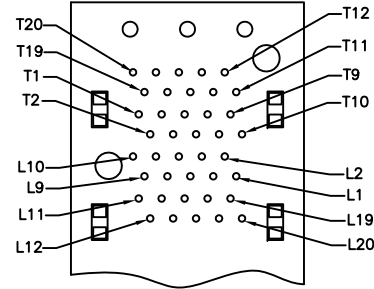
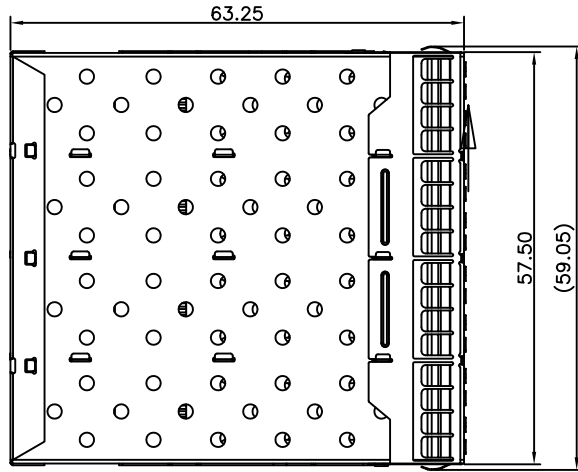

CONNECTOR PIN-OUT  
COMPONENT SIDE OF BOARD

DETAIL A  
1:1

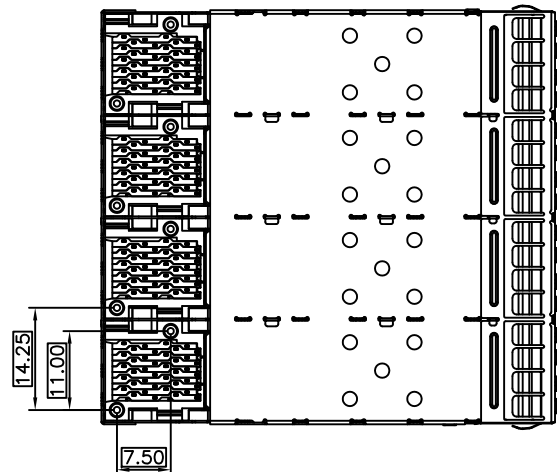
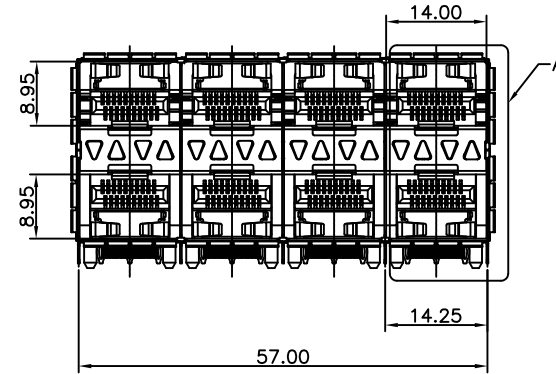
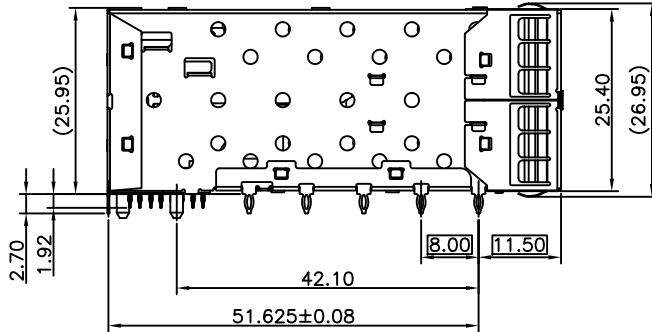

DIMENSIONS ARE IN INCHES TOLERANCES UNLESS OTHERWISE SPECIFIED: X ± X.X ± 0.10 X.XX ± 0.05 X.XXX ± ANGLES ± 1°	APPROVALS	NAME	DATE	东莞市洛程电子科技有限公司 DONG GUAN FU CHENG ELECTRONIC TECHNOLOGY Co., LTD  TITLE: SFP+ 2X4 COMBO WITH LIGHT PIPE WITHOUT GROUNDING PIN
	DESIGNED	陈佐君	2013.10.31	
	CHECKED			
	APPROVED			
	PROPRIETARY AND CONFIDENTIAL THE INFORMATION CONTAINED IN THIS DRAWING IS THE SOLE PROPERTY OF <YAEER ELECTRONICS>. ANY REPRODUCTION IN PART OR AS A WHOLE WITHOUT THE WRITTEN PERMISSION OF <YAEER ELECTRONICS> IS PROHIBITED.			SIZE A
MATERIAL&FINISH: SEE NOTES	DO NOT SCALE DRAWING	SCALE: 1:1	CUSTOMER DRAWING	DWG. NO. E90-K410-400X REV. A SHEET 2 OF 4

6 5 4 3 2 1

6 5 4 3 2 1

REV	ECN	LOCATIONS	DESCRIPTION	DATE	DESIGN	APVD
A	131031		PRODUCTION	2013.10.31	陈佐君	

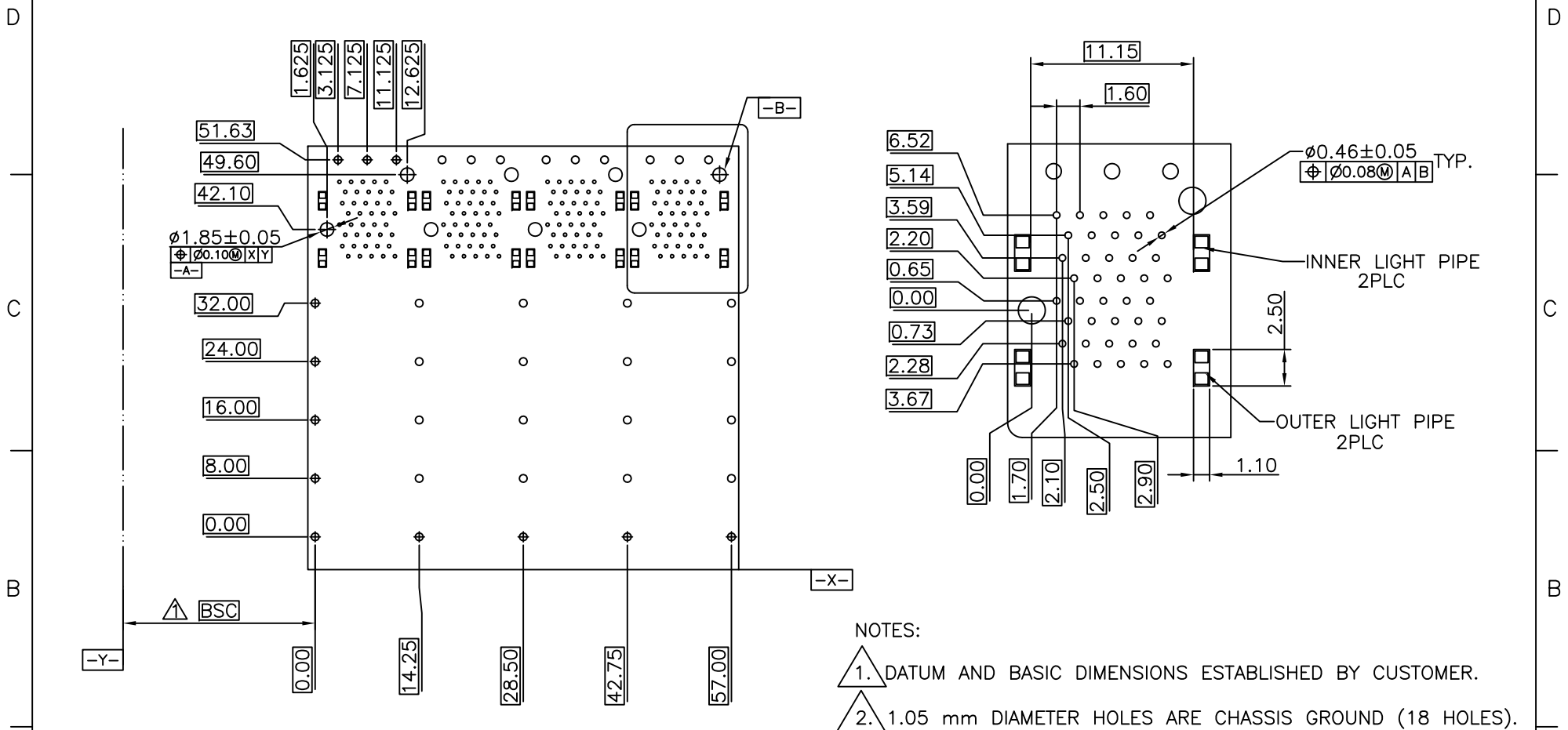

ECOMMENDED PCB CONFIGURATION

NOTES:

1. DATUM AND BASIC DIMENSIONS ESTABLISHED BY CUSTOMER.
2. 1.05 mm DIAMETER HOLES ARE CHASSIS GROUND (18 HOLES).

DIMENSIONS ARE IN INCHES TOLERANCES UNLESS OTHERWISE SPECIFIED: X.X ± 0.10 X.XX ± 0.05 X.XXX ± 0.01 ANGLES ± 1°	APPROVALS	NAME	DATE	东莞市浩程电子科技有限公司 DONG GUAN FU CHENG ELECTRONIC TECHNOLOGY Co., LTD
	DESIGNED	陈佐君	2013.10.31	
	CHECKED			TITLE:
	APPROVED			SFP+ 2X4 COMBO WITH LIGHT PIPE WITHOUT GROUNDING PIN
PROPRIETARY AND CONFIDENTIAL THE INFORMATION CONTAINED IN THIS DRAWING IS THE SOLE PROPERTY OF <YAEER ELECTRONICS>. ANY REPRODUCTION IN PART OR AS A WHOLE WITHOUT THE WRITTEN PERMISSION OF <YAEER ELECTRONICS> IS PROHIBITED.				SIZE
MATERIAL&FINISH: SEE NOTES				DWG. NO. E90-K410-400X REV. A
DO NOT SCALE DRAWING				SCALE: 1:1 CUSTOMER DRAWING SHEET 3 OF 4

6 5 4 3 2 1

6 5 4 3 2 1

REV	ECN	LOCATIONS	DESCRIPTION	DATE	DESIGN	APVD
A	131031		PRODUCTION	2013.10.31	陈佐君	

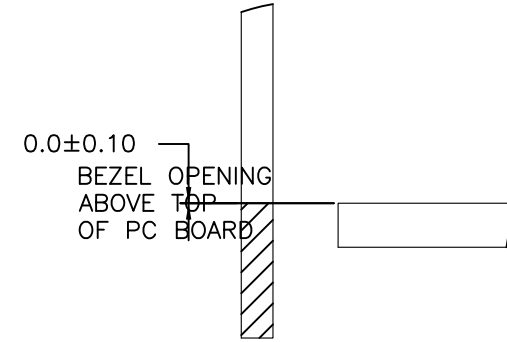
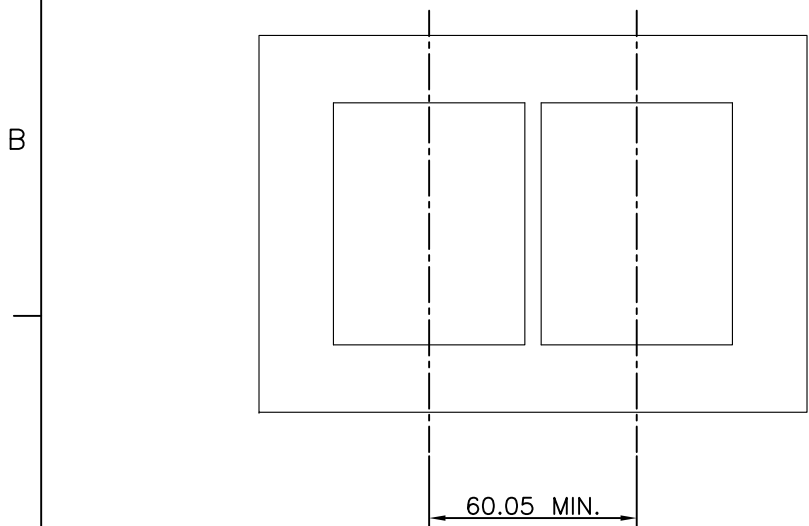
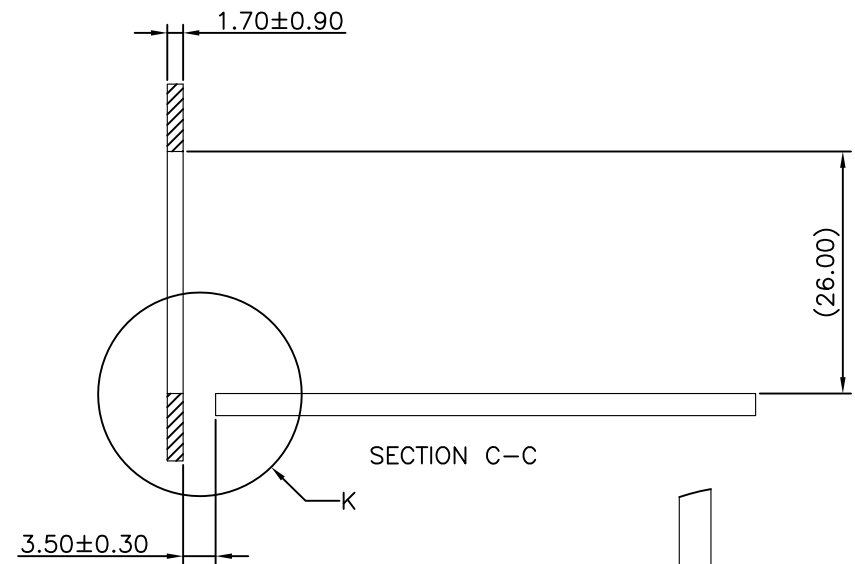
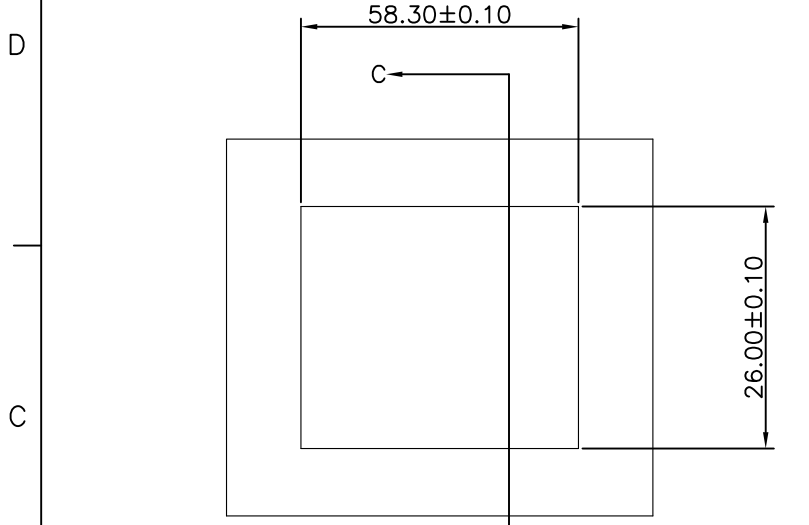

RECOMMENDED BEZEL DESIGN

DETAIL K  
2:1

DIMENSIONS ARE IN INCHES TOLERANCES UNLESS OTHERWISE SPECIFIED: X ± 0.10 X.X ± 0.05 X.XXX ± 0.01 ANGLES ± 1°	APPROVALS	NAME	DATE	东莞市浩程电子科技有限公司 DONG GUAN FU CHENG ELECTRONIC TECHNOLOGY Co., LTD TITLE: SFP+ 2X4 COMBO WITH LIGHT PIPE WITHOUT GROUNDING PIN SIZE A DWG. NO. E90-K410-400X REV. A
	DESIGNED	陈佐君	2013.10.31	
	CHECKED			
	APPROVED			
PROPRIETARY AND CONFIDENTIAL THE INFORMATION CONTAINED IN THIS DRAWING IS THE SOLE PROPERTY OF <YAEER ELECTRONICS>. ANY REPRODUCTION IN PART OR AS A WHOLE WITHOUT THE WRITTEN PERMISSION OF <YAEER ELECTRONICS> IS PROHIBITED.				
MATERIAL&FINISH: SEE NOTES		DO NOT SCALE DRAWING		SCALE: 1:1 CUSTOMER DRAWING SHEET 4 OF 4

6 5 4 3 2 1